



Partition Stalls

info@partitionstalls.com
646-453-4564

WE HIGHLY RECOMMEND YOU
COMPLETELY REVIEW BEFORE
STARTING YOUR INSTALLATION!

Installation Instructions

Powder Coated Steel & Stainless Steel Toilet Partitions

Type F/S –Floor Supported

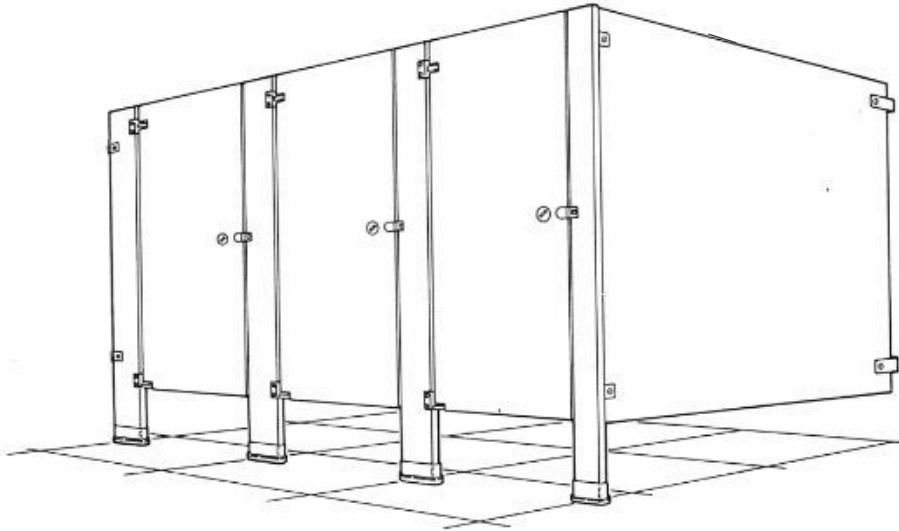











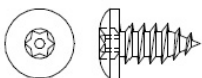

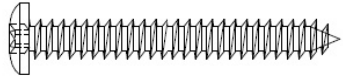
Important!

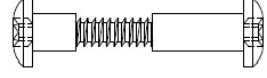
- Please read all instructions carefully and study the All American Metal prepared “final” layout drawings before starting your installation.
- Verify that all width and depth dimensions shown on layout drawings coincide with the actual field conditions.
- If factory pre-drilled pilasters were received, carefully review each for proper field location based on the prepared layout drawings.
- Instructions are based on our standard 58” high doors and panels with a 12” above finished floor dimension.
- Proper care and warranty information available at our website www.allamericanmetal.com

RECOMMENDED TOOLS AND SUPPLIES

- Tape Measure
- 4 Ft Level
- Chalk Line / Pencil
- Power Drill
- Hammer Drill
- Hammer
- Safety Glasses
- Adjustable Wrench
- Shims / Wedge
- Drill bits for ceramic and masonry 5/16" & 3/4"
- Drill bits for steel 1/4", 11/64" –with drill stop to prevent damage
- Screwdriver and/or driver bits (slotted and Torx security head)
- 12" high spacer block (large & strong enough to support panels)
- Painters Tape (optional)

SUPPLIED FASTENER TYPE AND USAGE

		<p>#14 X 9/16" Torx Sheet Metal Screw (For attaching all bracket locations to panels and pilasters)</p>
		<p>#14 X 2" Torx Screw (For attaching all bracket locations to walls)</p>
		<p>Plastic Anchor Shield (Used with #14 X 2" Torx Screws)</p>
		<p>#10-24 X 1-1/4" Sex bolt (Thru-Bolt) (For mounting hinges & strike/keeper to pilaster)</p>
		<p>#10 X 5/8" Torx Sheet Metal Screw (For mounting coat hooks and outswing door bumpers)</p>
		<p>#10 x 1" TORX Flat Head Sheet Metal Screw (For mounting "optional" aluminum privacy door strips)</p>
		<p>3/8" Double Expansion Shield (For anchoring floor bolt)</p>
		<p>3/8"-16 x 4" Threaded Bolt (For mounting pilaster to floor)</p>
		<p>3/8" Locking / Leveling Hex Nut 3/8" Flat Washer</p>

STEP 1 – LAYOUT

- A. Establish & mark center line of pilaster location from back wall. The center line will be 5/8" less than the overall compartment depth shown on drawings. Measure out at both ends of installation and draw a straight line connecting both marks.
- B. Beginning at side wall of pilaster centerline location, measure and mark dimensions for floor fastenings according to shop drawings. The floor fastenings are located 1" in from each edge of pilaster. (Only one floor fastening required on 3" & 4" pilasters & are fastened furthest from wall)
- C. Establish and mark panel center lines by measuring compartment width across the back wall. Continue this step for each panel using the previous panel centerline as starting point.
- D. Locate wall bracket height locations by marking each wall pilaster and panel centerline at 17" & 65" from floor.
- E. Using the bracket itself as a template, align and center bracket opening over the panel & pilaster center line and mark hole locations. Note the use of double-ear vs. single-ear bracket locations and panel (1") vs. pilaster (1-1/4").

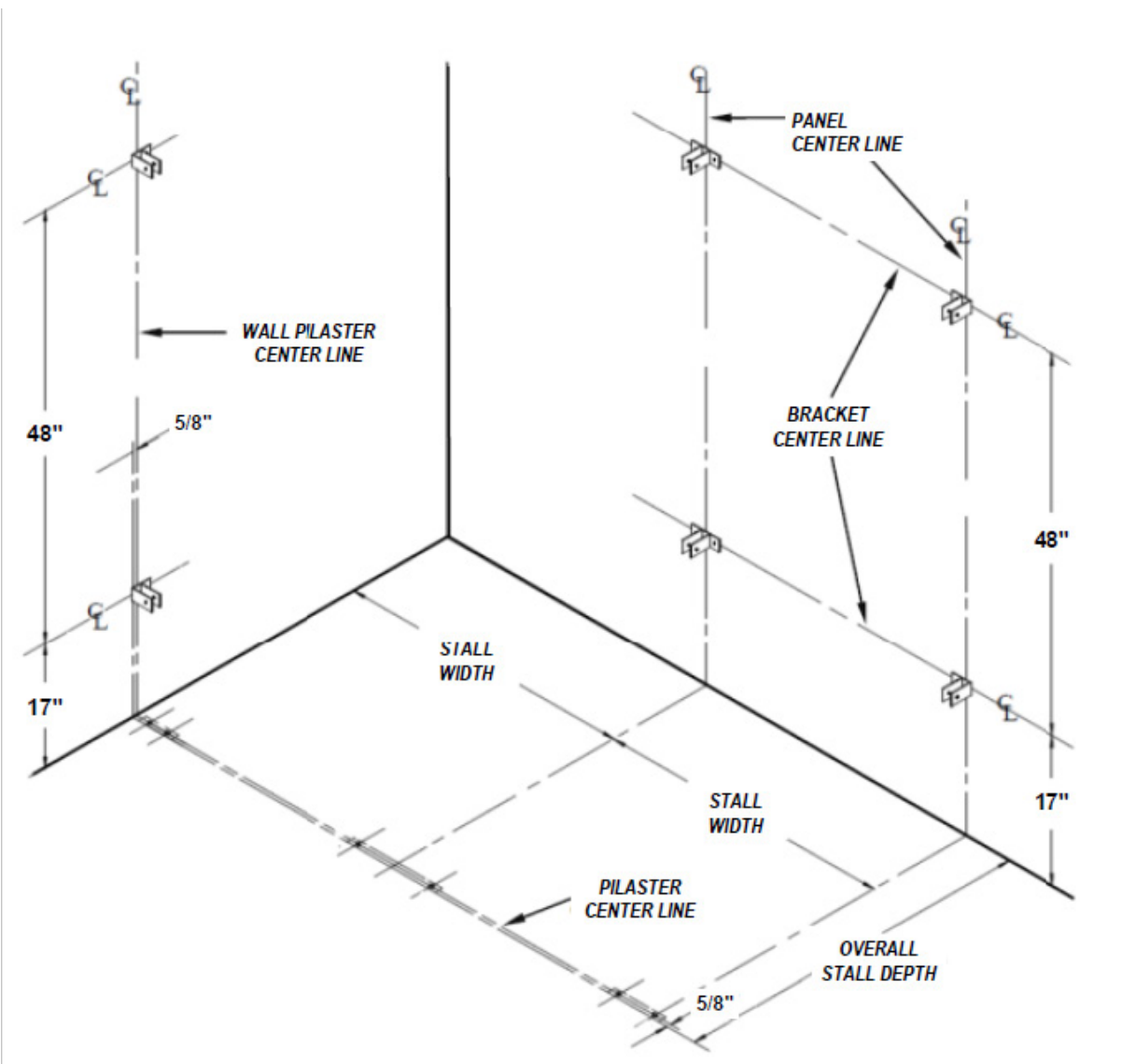

STEP 2 –MOUNTING BRACKETS AND FLOOR ANCHORS

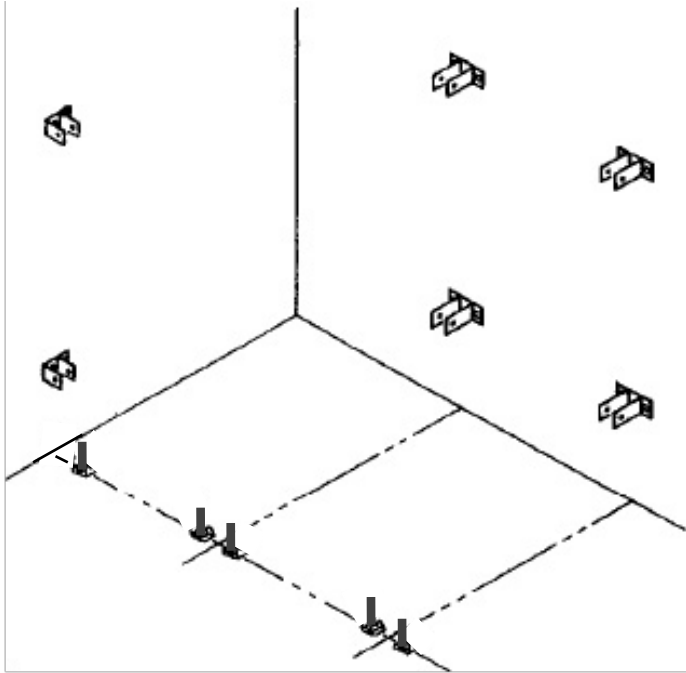

- A. Drill 5/16" diameter holes at all marked wall bracket locations.
- B. Insert plastic expansion anchor shields into all wall holes.
- C. Secure all brackets to wall with provided #14 X 1-1/2" fasteners.
- D. Hammer drill 3/4" diameter holes at all marked floor fastening locations at 2" minimum depth.
- E. Place double expansion anchor shields into floor holes –threaded half at bottom.
- F. Fully thread a 3/8" x 4" bolt into each floor anchor shield followed by a shoe clip first, then a 3/8" flat washer and 3/8" hex lock
- G. Tighten nut to expand and secure anchor shield to floor.
- H. Thread a second 3/8" hex nut onto bolt to within approx. 1/2" of first lock nut. Place another 3/8" washer on top. This provides your leveling adjustment (Step 4-D).

STEP 3 –POSITION PANEL

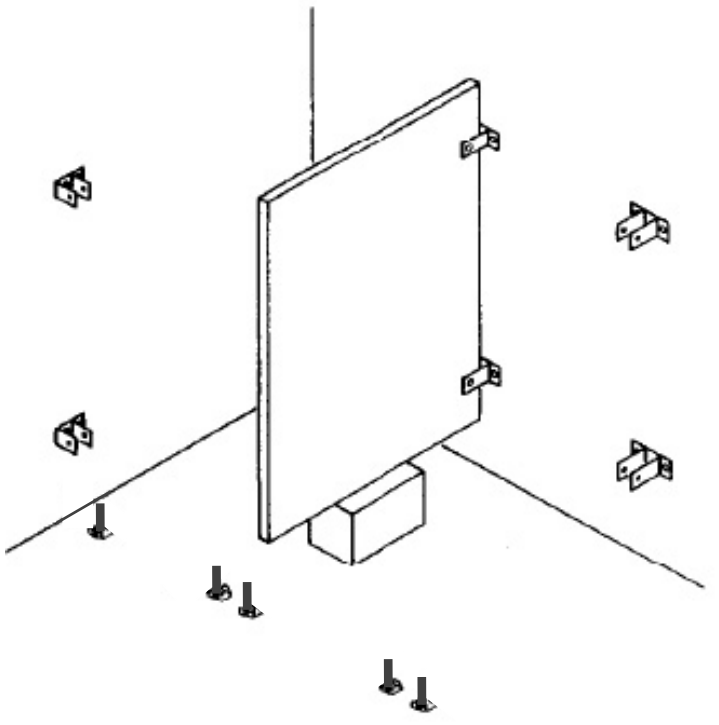

- A. Place a 12" high spacer block in position to support panel
- B. Rest panel onto the spacer block and slide carefully into wall brackets.
- C. Do not fasten panel to wall brackets at this time!

STEP 4 –PREPARE & ATTACH PILASTER TO FLOOR AND PANEL

*****IMPORTANT!!!** –For pilasters that have been factory pre-drilled for door hinge brackets carefully review shop drawings for proper placement of each pilaster on project.

*****NOTE!!!** -When field drilling the “U” bracket locations, determine the centerline of panel location on back of pilaster based on the prepared shop drawings. Be sure “U” bracket height will also be in alignment with wall brackets. Use the “U” bracket as a template to mark hole locations and drill ONLY two “diagonal” 11/64” holes. If required, field drilling for door hinges should also be performed at this time. Using the top & bottom hinge brackets as templates, mark hole locations and drill 1/4” holes. **Refer to drilling template on page 8.**

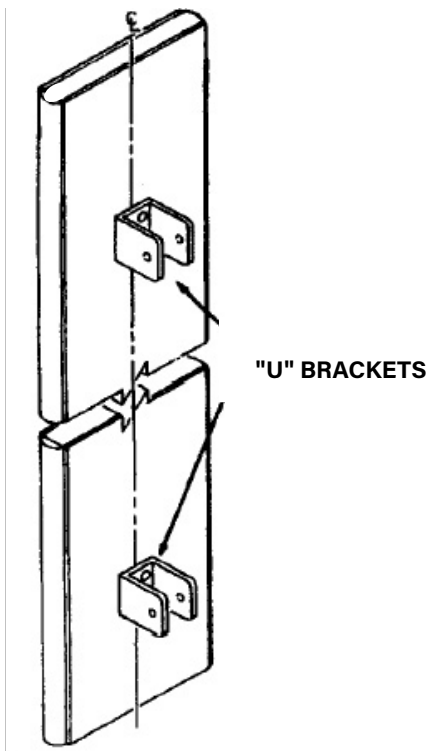

- A. Fasten panel “U” brackets to back face of pilasters at the pre-drilled locations using two #14 x 9/16” sheet metal screws for each bracket.
- B. Slide the stainless steel shoe carefully onto the mounting end of pilaster leaving approx. 5” space above bottom. (Painters tape can be used to hold position)
- C. Place pilaster mounting bar over the floor bolts and align panel into “U” brackets. Fasten pilaster to each floor bolt loosely with a 3/8” flat washer and locking nut.
- D. Plumb pilaster and set mounting height by carefully adjusting each leveling nut and lightly tighten locking nut to hold position.
- E. Fasten “U” brackets to panel by drilling 11/64” holes and using #14 x 9/16” sheet metal screws to secure. Top of panel & pilaster edge should align. (Be sure to place a shim or wedge at top rear between panel and wall to hold position before drilling.)
- F. Remove the panel support/spacer block.
- G. Repeat for each pilaster
- H. Do not lower shoe to floor at this time

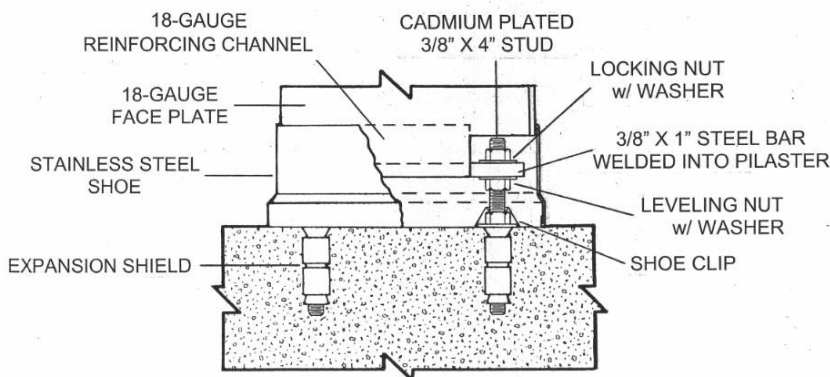

FLOOR MOUNTING DETAIL

STEP 5 –SET DOOR OPENINGS & ATTACH PANEL TO WALL

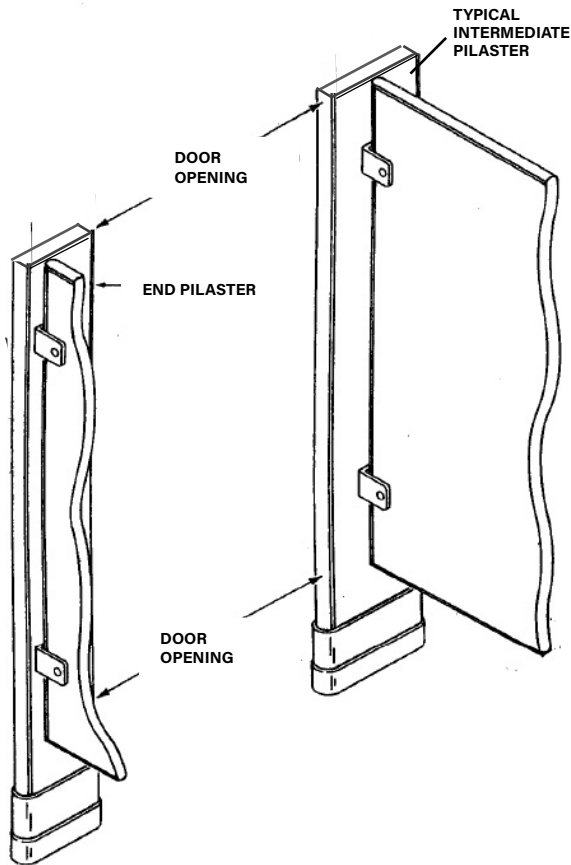

- A. Position wall pilaster into brackets – plumb and secure following step 4D. Do not fasten pilaster to brackets.
- B. Level tops of pilaster heights from one compartment to next with minor adjustments to leveling nuts if necessary.
- C. Using the wall pilaster as a reference point, position each pilaster to the required door opening size and secure by tightening the lock nuts onto pilaster mounting bars.
- D. Drill 11/64" holes and secure all panels and wall pilasters to wall brackets with #14 x 9/16" sheet metal screws."
- E. Remove shim / wedge from back wall.
- F. Carefully slide stainless steel shoe down the pilaster to floor, locking it into place over the shoe clip.

STEP 6 –INSTALLING DOORS

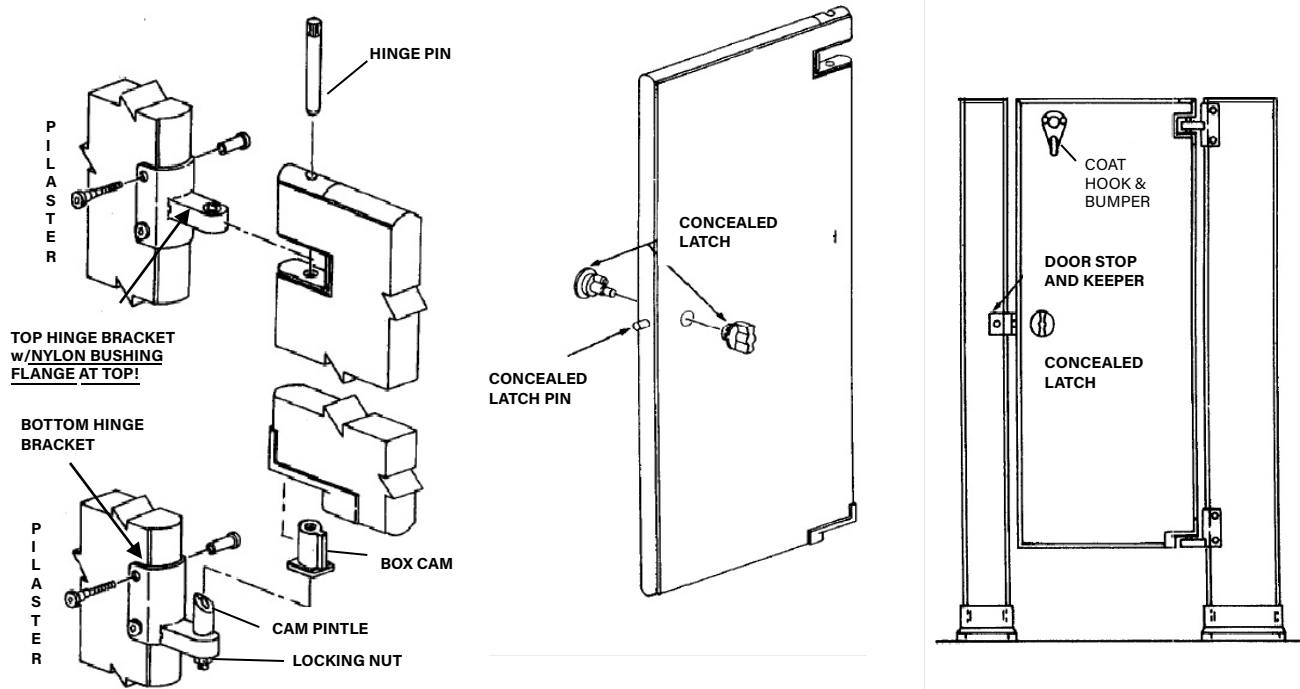

- A. Mount top and bottom pilaster hinge brackets onto the factory pre-drilled locations using threaded through-bolts as supplied. (If field drilling the hinge brackets, use the attached drilling template and perform prior to completing Step 4)
- B. Insert nylon box cam into the recess found within hinge assembly (factory built-in) at bottom of door and tap into place.
- C. Hang the door by placing the box cam carefully over the attached cam pintle of bottom hinge bracket while positioning the top door hinge assembly (factory built-in) over the top hinge bracket. Place stainless steel hinge pin into top opening of door and tap GENTLY while maintaining alignment of pin through the remaining top hole of casting, through the hinge bracket bushing and finally back into door. Tap until pin is flush with top of door.
- D. To set angle of door opening, adjustment to the cam pintle is required. Loosen the 1/2" nut fastened to bottom hinge bracket and position door to the desired "resting" position. Using a slotted screwdriver at base of bolt to maintain door position, re-tighten the 1/2" nut to secure. *Note!- DO NOT OVERTIGHTEN. Excessive force can damage door pintle.
- E. On the exterior of compartment, install the slotted emergency access cover plate through front of door. While holding cover plate in place, align with the inside turning latch/knob and slowly press pieces together until flush with door surfaces. For ADA compliance doors, use the special lever latch instead for interior of compartments. *Note!- Do not assemble door latches together prior to installing through door. Pressure sensitive attachment hardware will not allow for re-assembly.
- F. Align door stop & keeper with latch bolt and using the stop & keeper hardware as template, drill 1/4" hole and fasten with 1-1/4" threaded through-bolt.
- G. Attach coat hook with #10 x 5/8" sheet metal screws. (*Note – Inswing doors supplied with combination coat hook/bumper design and Outswing doors supplied with 2-prong coat hook without bumper design.) Check local codes for mounting height on ADA doors.
- H. Attach door pull. One door pull is supplied for each outswing door and all ADA compliant doors receive two (back to back) door pulls.

HARDWARE DRILLING TEMPLATE

TYPE F/S –Floor Supported

